

# LOCATION OF TRANSMITTERS

ROOM= HATCH

A- DECK

ROOM 4

ROOM 3

ROOM 2

ROOM 1

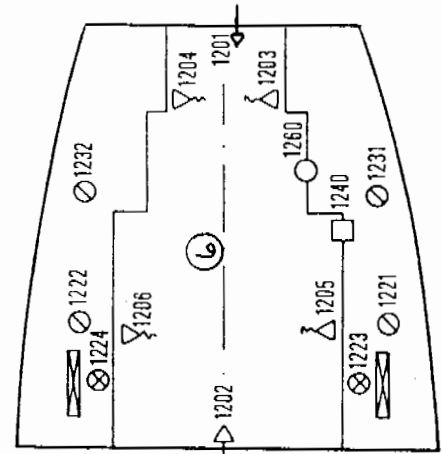
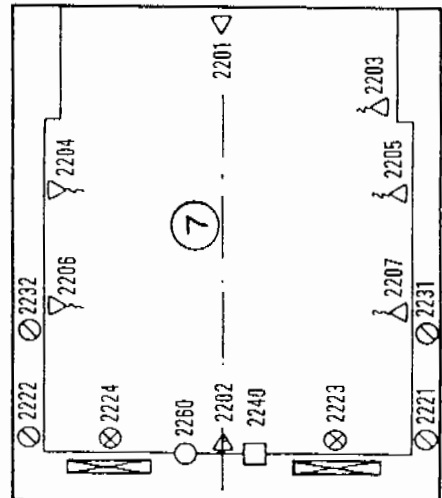
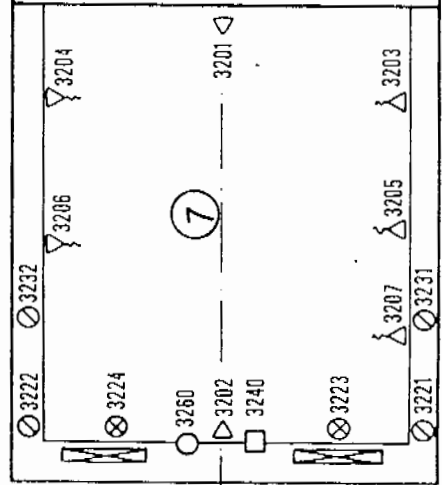
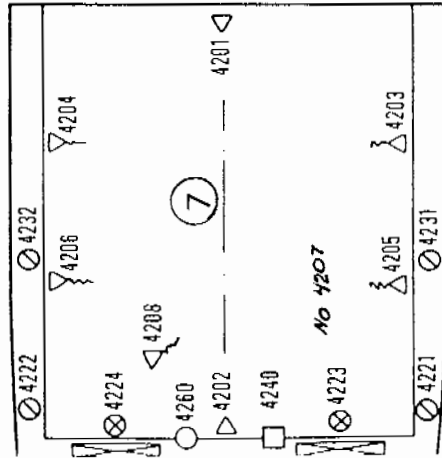
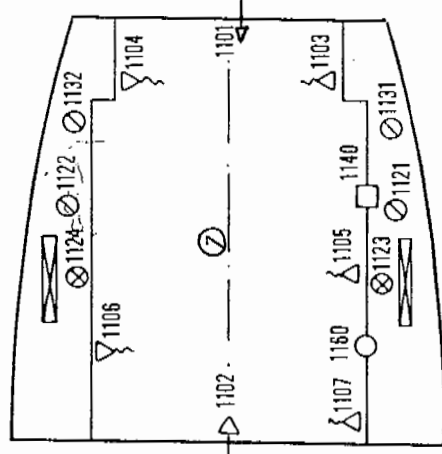
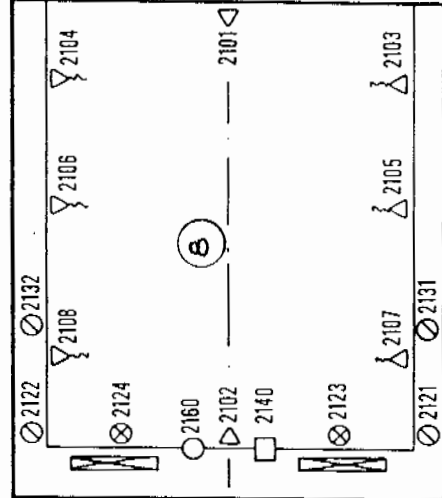
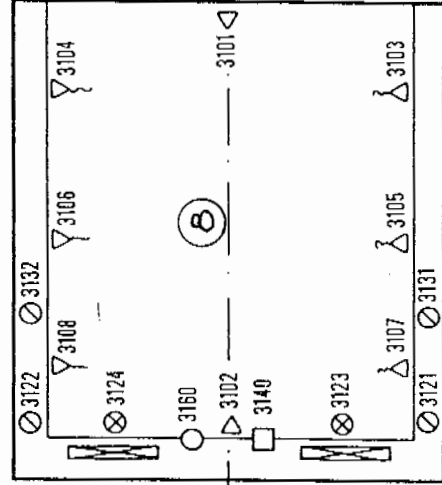
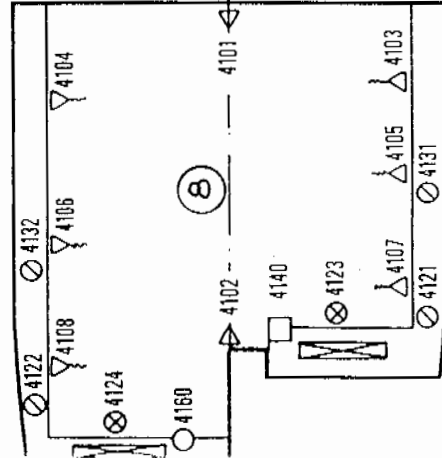

B- DECK

C- DECK

ROOM 1

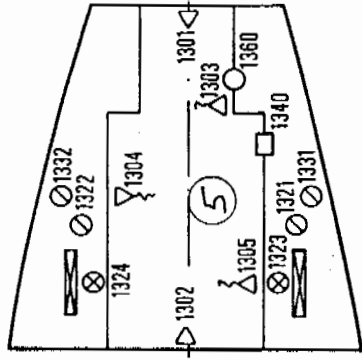

ROOM 2

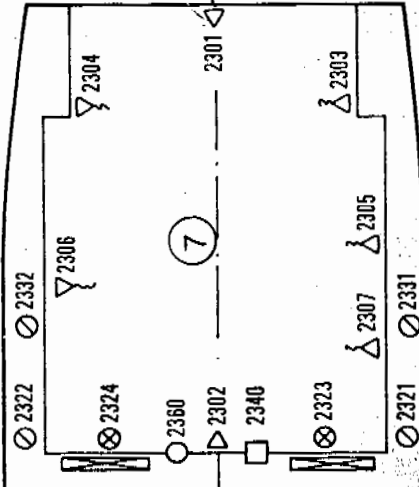

ROOM 3

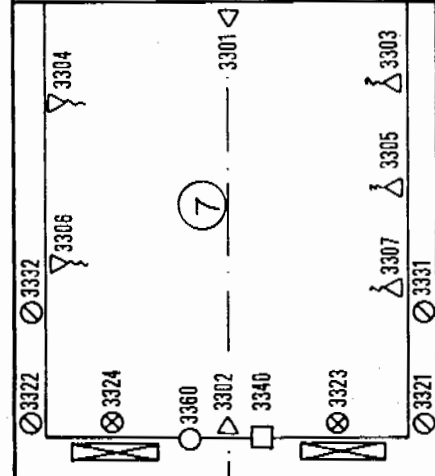

ROOM 4

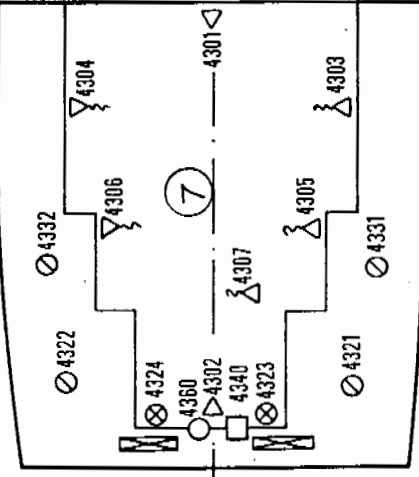

539  
549

ROOM 4

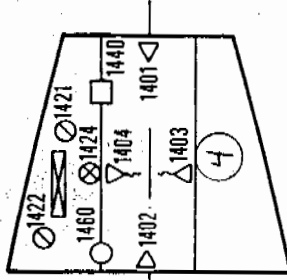

ROOM 5

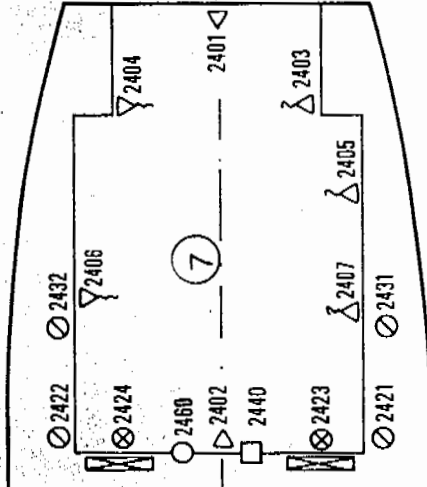

ROOM 6

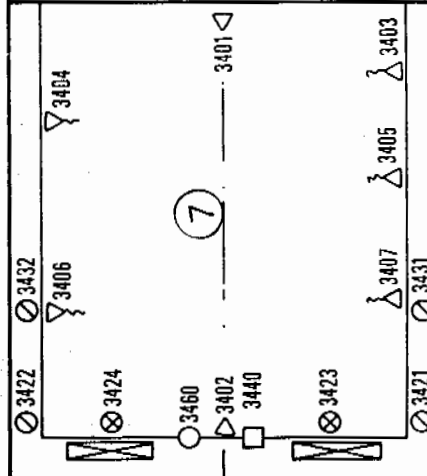

D- DECK

ROOM 3

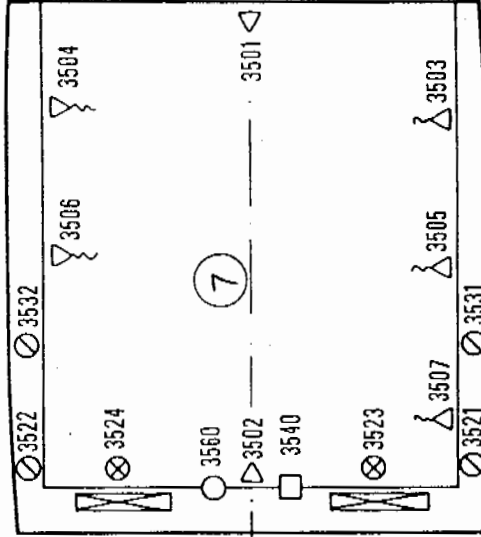

ROOM 2

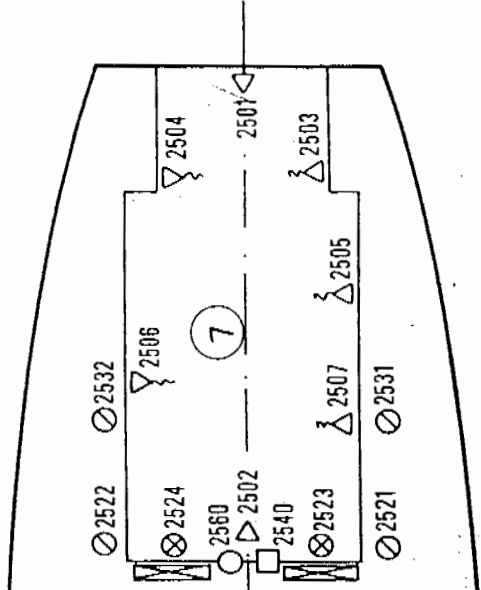

E-DECK

# WINTERVESSELS      USDA - Sensorplan

Hatch no 4		Hatch No 3		Hatch No 2		Hatch No 1				
4108	4106	4104	3108	3106	3104	2108	2106	2104	1106	1104
4102	4102	4101	3102	3101	3101	2102	2101	2101	1102	1101
4107	4105	4103	3107	3105	3103	2107	2105	2103	1107	1105
	4206	4204		3206	3204		2206	2204	1206	1204
4202	4208	4201	3202	3201	3201	2202		2201	1202	1201
	4205	4203	3207	3205	3203	2207	2205	2203	1205	1203
	4306	4304		3306	3304		2306	2304	1304	
4302	4307	4301	3302	3301	3301	2302		2301	1302	1301
	4305	4303	3307	3305	3303	2307	2305	2303	1305	1303
			3406	3404	3404		2406	2404	1404	
			3402		3401	2402		2401	1402	1401
			3407	3405	3403	2407	2405	2403	1403	
				3506	3504		2506	2504		
			3502		3501	2502		2501		
			3507	3505	3503	2507	2505	2503		

A

B

C

D

E